

- Made of High Quality Stainless Steel for Durability & Reliability
- Stainless Steel Glycol Recirculation Loop+ Tube for Optimum Cooling Transfer
- Modern Look with Brushed Stainless Finish
- Precision Flow Control Taps Included



C1216

Brushed Stainless

Revision # 1 - -
Copyright © 2017 Krome Dispense. All Rights Reserved



Specifications Available:-

Part No	Faucets	Finish	Cooling System
C1216	3	Brushed Stainless	Glycol Recirculation Loop+
C1213	3	SS Polished	Glycol Recirculation Loop+
C1214	3	Polished Copper	Glycol Recirculation Loop+
C1215	3	Brushed Copper	Glycol Recirculation Loop+

Product Dimensions:-

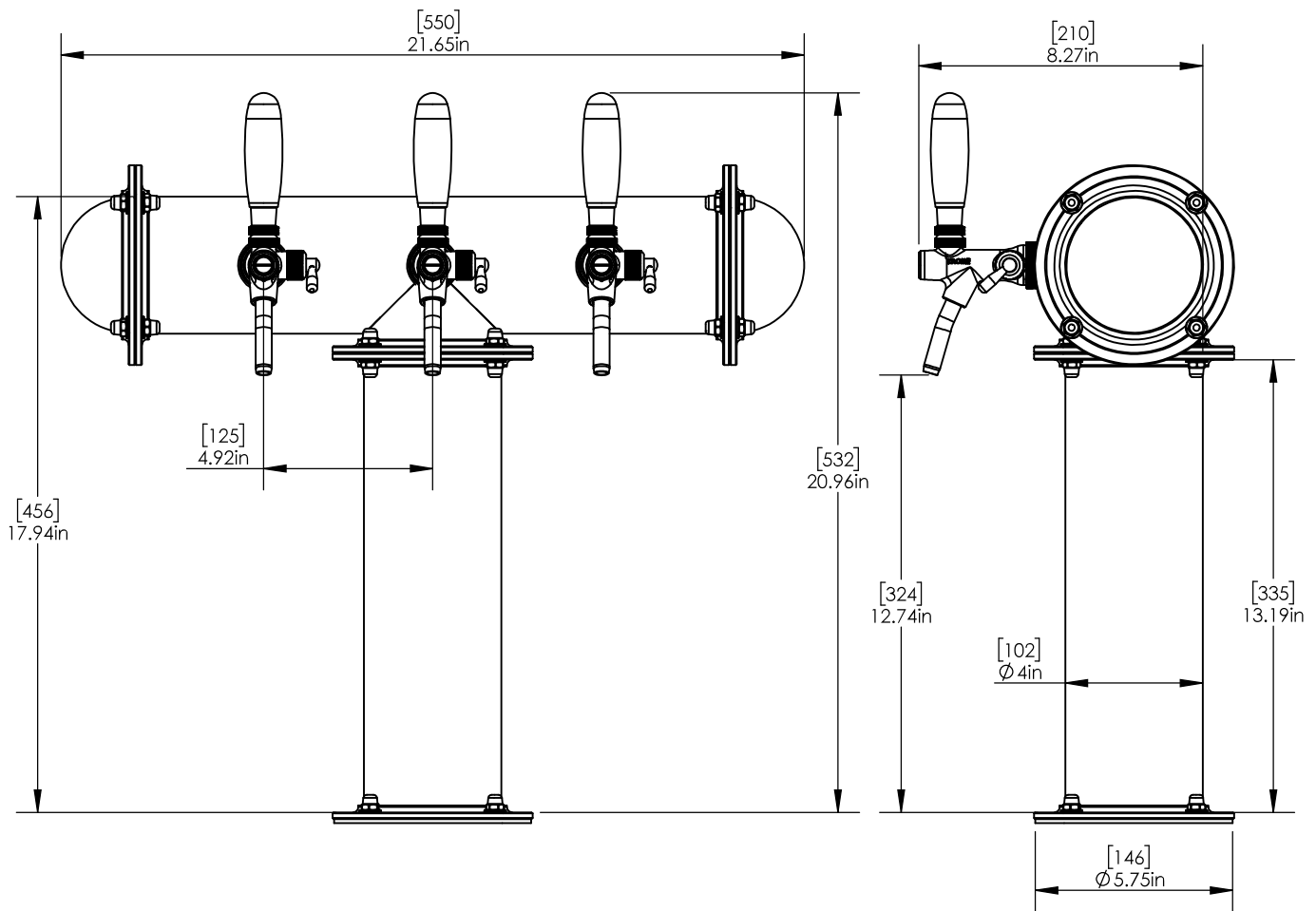

Revision # 1 - -

Copyright © 2017 Krome Dispense. All Rights Reserved

US & Canada :- +1-678 666 2001

Asia:- +91-9814203010

Krome Dispense reserves the right to make revisions to product specifications without any notice
For most updated specification sheet , go to www.kromedispense.com

